

GFM-C Series

GFM-400C 2V400Ah

GFM-C series VRLA battery uses latest AGM technology, high purity raw materials and many patented technologies that ensure its long floating and cycle life, it is applicable to less frequency of power failure, and shallow discharge of depth site. It is mainly used for indoor telecommunication base station.



Benefits

- Long life according to EUROBAT Classification
- High discharge performance
- 99%+ gas recombination efficiency
- Maximum charge efficiency
- Low self-discharge rate
- Horizontal installation

Applications

- Telecommunications
- Power system
- UPS
- Emergency power

Standards

- IEC 60896-21/22
- JIS C8704-1/2
- EUROBAT guide

Drawing

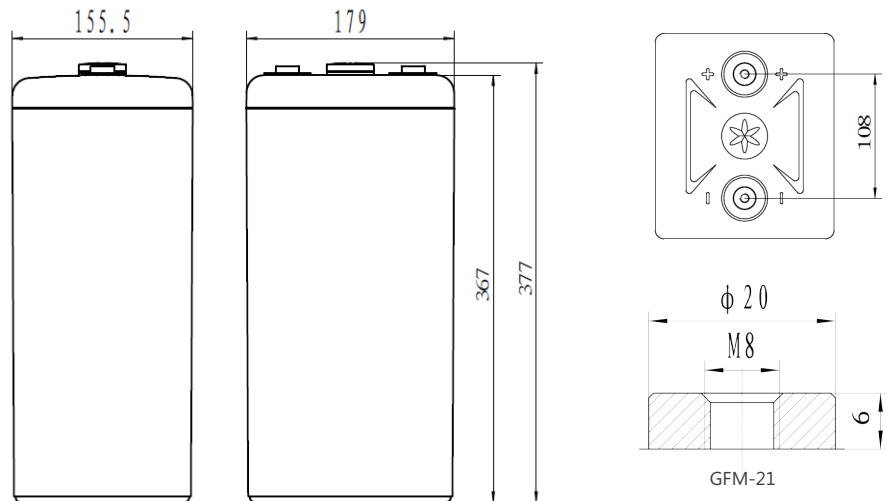

Specifications

Battery Model	GFM-400C			
Design Life (years, 25°C)	15			
Capacity (Ah, 25°C)	10HR (40A, 1.80V)	5HR (68A, 1.80V)	3HR (100A, 1.80V)	1HR (220A, 1.75V)
	400	340	300	220
Dimensions (mm)	Length	Width	Height	Total Height
	155.5	179	367	377
Approx. Weight (kg)	23.3			
Reference Internal Resistance (mΩ)	0.45 (fully charged @ 25°C)			
Maximum Discharge Current (A/5 Sec.)	1400			
Self-Discharge (25°C)	≤ 1.5% per months			
Charge Voltage (V/cell, 25°C)	Cycle use		Float use	
	2.35 (-3.5mV/°C/cell), max charge current: 60A		2.25 (-3.5mV/°C/cell)	
Short Circuit Current (A)	4600			

Discharge Data

Constant Current Discharge Data (25°C, A)															
End Voltage (V/cell)	min							h							
	5	10	15	20	30	40	50	1	1.5	2	3	5	8	10	24
1.60	608	560	524	472	384	352	300	272	213	157	116	79.2	54.4	44.0	19.4
1.65	568	524	488	440	356	320	280	256	196	150	112	76.0	52.8	43.2	19.0
1.70	516	472	432	400	328	292	264	240	182	144	108	72.8	51.2	42.2	18.7
1.75	468	416	376	344	300	268	240	220	168	136	104	70.4	49.6	41.2	18.2
1.80	400	368	336	312	272	244	220	200	157	128	100	68.0	48.0	40.0	17.7

Constant Power Discharge Data (25°C, W/cell)															
End Voltage (V/cell)	min							h							
	5	10	15	20	30	40	50	1	1.5	2	3	5	8	10	24
1.60	1042	971	915	828	678	625	535	487	383	284	212	147	102	83.0	37.1
1.65	994	928	870	788	641	579	509	467	359	278	208	143	100	82.5	36.9
1.70	922	852	785	730	602	539	489	446	341	271	205	139	99.8	81.8	36.6
1.75	853	766	696	640	561	504	453	416	319	260	200	136	96.7	80.5	35.8
1.80	741	688	632	589	516	465	420	383	301	247	194	133	94.2	78.7	35.0

Rack Layout

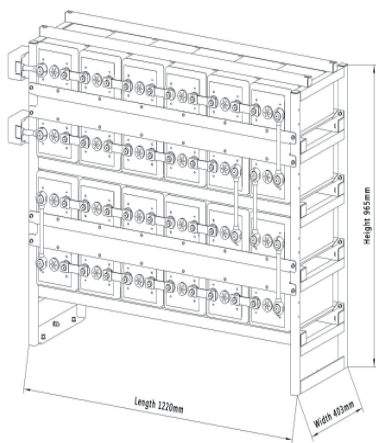

48V Standard Rack (Anti-seismic rack is optional)
 Rack material: powder-coated steel
 Height*width: 6*4/4*6 (optional)
 Ref. GFM-400C Rack (approx. weight: 617kg)

Performance Curve

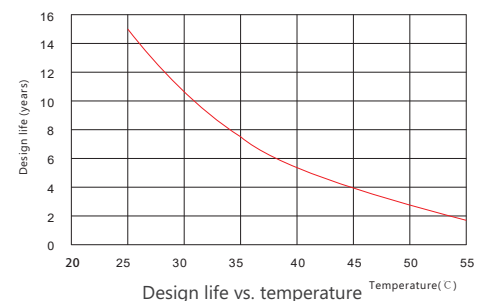
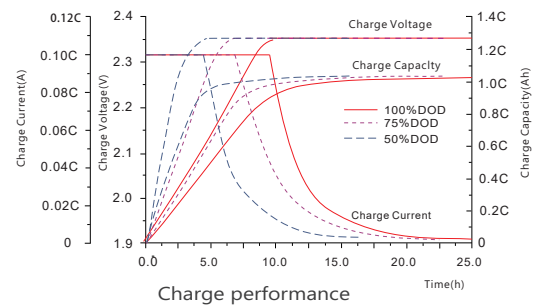
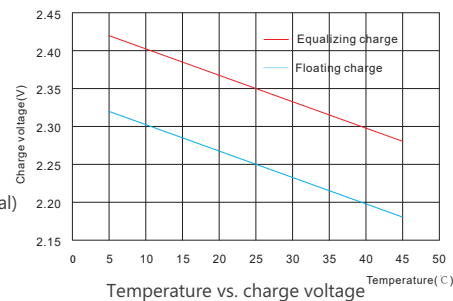
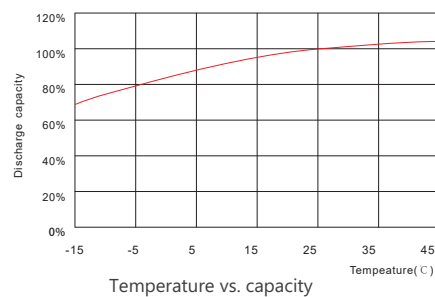

Sacred Sun Power Sources Co., Ltd.

Add: No.1 Shengyang Road, Qufu 273100 PRC
 Tel: +86-537-4422313 Fax: +86-537-4411980
 Email: sales@sacredsun.cn

Sacred Sun Hong Kong Co., Limited

Add: RM 19C Lockhart CTR 301-307 Lockhart RD Wan Chai, Hong Kong
 Email: admin.hk@sacredsun.hk

Sacred Sun Asia Pacific Pte Ltd.

Add: 1 Ubi View, #04-12, Focus One, Singapore 408555
 Email: admin.sg@sacredsun.sg

Sacred Sun Europe SARL

Add: ZAE Fontaine, 33210 Fargues, France
 Email: admin.eu@sacredsun.eu

Sacred Sun MEA FZE

Add: No. 311 office, Building LOB 14, JAFZA, Dubai, UAE
 Email: admin.ae@sacredsun.ae

