

OPzV Series

8 OPzV 800 2V800Ah

Sacred Sun OPzV series are valve regulated lead-acid cells which use a combination of tubular positive plate woven gauntlets, pasted negative plate design and gel electrolyte using advanced filling techniques in production which assure superior service life and excellent battery reliability. The battery has excellent cyclic performance and charge acceptance ability. It can be used in high-low temperature environment and poor grid condition.

Benefits

- Very long life according to EUROBAT Classification
- 1500+ cycles at 80% DOD
- High rate discharge performance
- High gas recombination efficiency
- Maximum charge efficiency
- GEL state electrolyte prevents leakage and layering
- Low resistance PVC or PF micro-porous separator ensures low self-discharge rate
- Optional racking offers easy installation (vertical or horizontal)



Applications

- Telecommunications
- Energy storage system
- Hybrid power system
- Power system
- UPS

Drawing

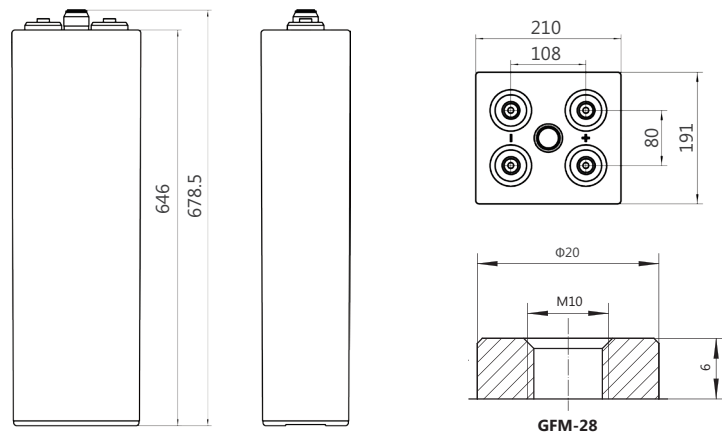

Standards

- IEC 60896-21/22
- IEC 61427
- DIN 43539-T5
- DIN 40742
- EUROBAT guide

Specifications

Battery Model	8 OPzV 800			
Design Life (years, 25°C)	20			
Capacity (Ah, 25°C)	10HR (80A, 1.80V)	5HR (136A, 1.80V)	3HR (200A, 1.80V)	1HR (400A, 1.80V)
	800	680	600	400
Dimensions (mm)	Length	Width	Height	Total Height
	191	210	646	678.5
Approx. Weight (kg)	60.0			
Reference Internal Resistance (mΩ)	0.37 (fully charged @ 25°C)			
Maximum Discharge Current (A/3 Sec.)	3548			
Self-Discharge (25°C)	≤ 3% per month			
Charge Voltage (V/cell, 25°C)	Cycle use		Float use	
	2.35 (-3.5mV/°C/cell), max charge current: 160A		2.25 (-3.5mV/°C/cell)	
Short Circuit Current (A)	5540			

Discharge Data

Constant Current Discharge Data (25°C, A)																		
End Voltage (V/cell)	min					h												
	5	10	15	20	30	1	2	3	5	6	8	10	20	24	48	100	120	240
1.65	1071	964	891	817	672	461	301.3	235.5	162.1	137.3	106.1	90.4	47.3	40.2	21.40	10.37	8.72	4.52
1.70	1025	893	831	771	644	440	285.3	222.9	153.3	129.6	101.9	87.2	46.3	39.6	21.31	10.35	8.68	4.51
1.75	947	843	777	717	624	421	269.3	211.2	145.3	124.8	97.9	84.0	44.0	38.4	21.04	10.32	8.64	4.48
1.80	887	796	729	665	568	400	254.4	200.0	136.0	116.3	94.1	80.0	42.9	35.92	20.80	10.28	8.60	4.45
1.85	823	721	667	604	533	381	241	189.3	130.4	112.3	89.1	75.7	41.7	35.6	20.51	10.20	8.56	4.44

Constant Power Discharge Data (25°C, W/cell)																		
End Voltage (V/cell)	min					h												
	5	10	15	20	30	1	2	3	5	6	8	10	20	24	48	100	120	240
1.65	1793	1638	1487	1349	1136	790.1	526.0	394.0	321.9	272.4	219.0	176.6	93.9	81.00	43.33	20.93	17.47	9.07
1.70	1723	1572	1417	1293	1088	765.6	506.0	380.0	310.5	262.9	211.4	174.5	92.0	79.47	42.67	20.70	17.36	9.02
1.75	1639	1509	1366	1245	1056	752.0	494.0	372.0	302.9	255.2	205.7	168.0	90.7	76.76	42.13	20.65	17.29	8.96
1.80	1553	1420	1284	1175	1013	732.0	482.7	366.0	281.9	238.1	198.1	164.0	89.0	72.20	41.60	20.55	17.20	8.92
1.85	1461	1265	1152	1046	912	705.3	462.0	350.0	257.1	226.7	183.8	154.9	86.1	71.15	41.00	20.44	17.15	8.88

Rack Layout

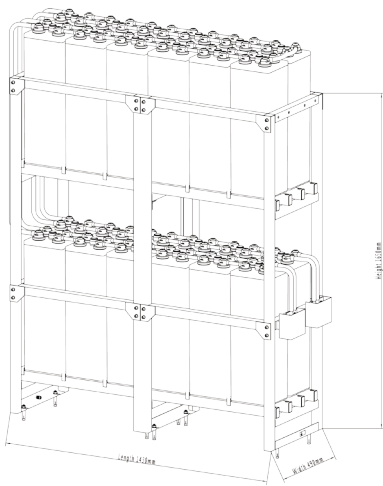

48V Standard Rack
 Rack material: powder-coated steel
 Height*width: 2*2
 Ref. 8 OPzV 800 Rack (approx. weight: 1620kg)

Performance Curve

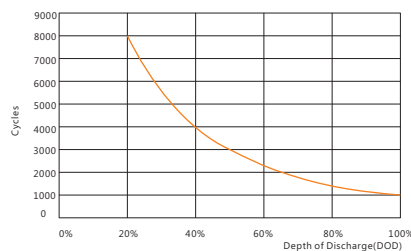

Cycle life vs. discharge depth

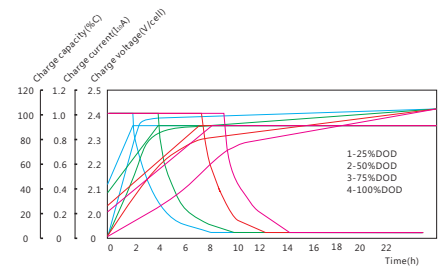

Charge vs. discharge depth

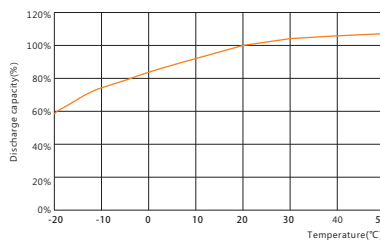

Capacity vs. temperature

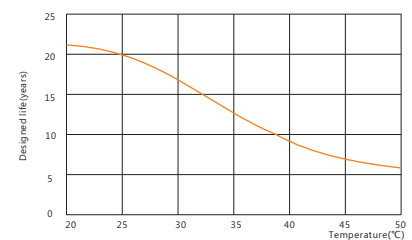

Design life vs. temperature

Sacred Sun Power Sources Co., Ltd.

Add: No.1 Shengyang Road, Qufu 273100 PRC
 Tel: +86-537-4422313 Fax: +86-537-4411980
 Email: sales@sacredsun.cn

Sacred Sun Hong Kong Co., Limited

Add: RM 19C Lockhart CTR 301-307 Lockhart RD Wan Chai, Hong Kong
 Email: admin.hk@sacredsun.hk

Sacred Sun Asia Pacific Pte Ltd.

Add: 1 Ubi View, #04-12, Focus One, Singapore 408555
 Email: admin.sg@sacredsun.sg

Sacred Sun Europe SARL

Add: ZAE Fontaine, 33210 Fargues, France
 Email: admin.eu@sacredsun.eu

Sacred Sun MEA FZE

Add: No. 311 office, Building LOB 14, JAFZA, Dubai, UAE
 Email: admin.ae@sacredsun.ae

